



for a greener tomorrow



FACTORY AUTOMATION

MITSUBISHI CNC M800/M80 Series





Infinite Possibilities

High productivity, usability and flexibility delivered by breakthrough performance.
The next-generation CNC M800/M80 Series empowers the manufacturing industry with unlimited possibilities and the capability to create innovative value.



The Best Partner for Your Success

CNC-DEDICATED CPU.....P2
ADVANCED DESIGN.....P3
INTUITIVE USABILITY.....P5
CNC LINEUP.....P7
SYSTEM CONFIGURATIONS.....P9
ENHANCED LATHE SYSTEM.....P11
ENHANCED MACHINING
CENTER SYSTEM.....P13

UNIQUE CUSTOMIZATION.....P15
REINFORCED FUNCTIONAL SAFETY.....P16
SUPPORT FOR AUTOMATION.....P17
EXCELLENT MAINTAINABILITY.....P19
HARDWARE.....P20
SPECIFICATIONS.....P21
DRIVE SYSTEM.....P23
SOFTWARE TOOLS.....P25

GLOBAL SERVICE NETWORK.....P27
WARRANTY.....P29
YOUR SOLUTION PARTNER.....P30

CNC-DEDICATED CPU

Mitsubishi Electric's first CNC-dedicated CPU, the sum of our industry-leading technologies.



Development of convention-breaking CNCs

Leading the way in today's industrial globalization, the innovative products of Mitsubishi Electric continue to exceed the expectations of users around the world. The outstanding performance of our CNC lineup consistently wins praise from users for their high levels of productivity, intuitive usability, and superior functionality. However, to develop the new M800/M80 Series, we went back to the drawing board and completely reexamined our cutting-edge control technologies. The result is a breakthrough in the control of high-speed, high-precision machining.

User performance requirements demand a commitment to development

The story of the new M800/M80 Series began with conventional development to produce incremental evolutionary improvements. But our goal was a revolutionary leap in CNC performance. Our project team determined that the only way to significantly boost processing performance and totally satisfy user demands would be the creation of a CPU optimized for CNC control. This insight inspired Mitsubishi Electric's first-ever attempt to develop a CNC-dedicated CPU and opened a new chapter in CNC development.

In-depth analysis and simulations achieve one volition

Pursuit of CNC-dedicated CPU began with design validation on an unprecedented scale as well as high-precision simulations to verify processing performance. Achieving a leap in processing performance demanded the integration of innovative technologies beyond optimizing processor manufacturing processes. Overcoming numerous hurdles and maximizing the potential of the processor, we succeeded in producing a CNC-dedicated CPU that achieves unprecedented high-speed processing performance.

Experience the revolutionary high-speed processing of the new CNC-dedicated CPU

Incorporating the CNC-dedicated CPU in the new series not only results in phenomenal processing speed, but also reduces the number of required parts, leading to fewer possibilities of failure and increasing product quality. Equipped with Mitsubishi Electric's first-ever CNC-dedicated CPU, the long-awaited M800/M80 Series is the fruit of an original development process and the sum of our latest technologies. With the utmost confidence, we are proud to introduce the M800/M80 Series and invite customers to experience performance of the future today.

Fine segment processing capacity



High capability in program processing enables a shorter cycle time.

PLC process capability (PCMIX value)



High processing capability of the PLC enables large-scale ladder logic to be processed at high speed.

CNC-to-drive communication capability



Optical communication speed between CNC and drive has been increased. This improves the system responsiveness, leading to more accurate machining.

ADVANCED DESIGN

Display and keyboard design have been renewed. The advanced construction and sophisticated flat profile take machine design to the next level. The display incorporates a touchscreen as standard specifications, providing intuitive smartphone-like operation (10.4-type and wider displays).



19-type touchscreen provides easy operability (for M800W/M80W Series only)



Software keyboard



Software operation panel



Document viewer



Memo pad (handwritten)

19-type vertical display unit provides two-split multiple windows for various applications

A 19-type vertical display is included in the M800W/M80W Series. The display provides two-split multiple windows that can be customized by arranging the software keyboard, document viewer or other application.

The slim personal computer unit enables greater flexibility in operation panel design

M800W/M80W Series personal computer unit boasts 50mm thick (excluding protrusions). This provides a higher degree of flexibility in operation panel design.

Slim 9.5mm shape (excluding protrusions)



Advanced display and keyboard designs



M700V/M70V M800/M80

The M800/M80 Series accommodates an SD card, a relatively easy-to-source device. The SD card can be inserted or removed independently of USB memory. The flip-up door provides greater durability.



Possible to be mounted not only from the front side of machine tools but also from the inner side of cabinets.

Display redesigned for enhanced visibility of keyboard

The display and keyboard have been redesigned. Measuring only 9.5mm thick (excluding protrusions), the possibilities of machine tool design have been expanded. In addition, their gray-scale colors can be easily harmonized with machines in different colors. The surfaces of display and keyboard are flush, providing beauty and usability as well as increased operability.

10.4-type and larger displays have touchscreen made of beautiful, long-life glass, which allows you easy day-to-day maintenance.

Vertical mount and horizontal mount keyboards are included in the product line.

INTUITIVE USABILITY



Touch operation provides you unprecedented ease of use.

Smartphone-like intuitive touch operation

The display features a capacitive touchscreen that is commonly used in smartphones and tablets, allowing for intuitive and easy operation. With a simple flick of the finger, for instance, you can monitor the desired part of program, or view and select a menu key on the next page without the need for tedious key operation.

In 3D graphic check, you can view a 3D model at any desired size, in any desired position.



Drag



Program edit (flick)

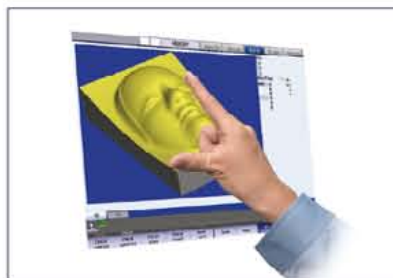

Pinch-in/Pinch-out

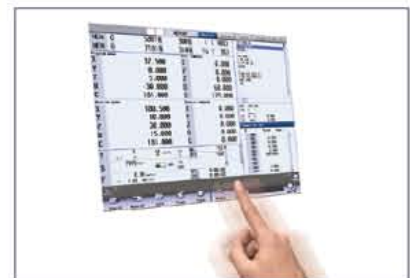

Menu scroll (flick)

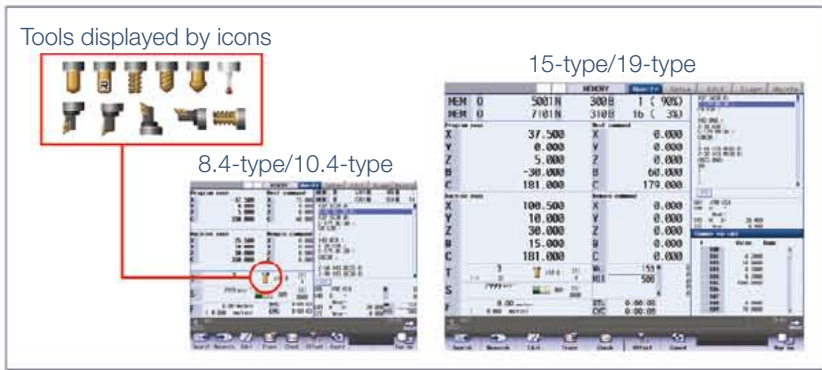

Various features and operation menus are indicated using easy-to-recognize icons. Tool icons tell you the tool type, left- or right-hand, lifetime and other information at a glance.

Advanced universal design with a focus on ease of use

The easy-to-use interface inherited from M700V/M70V Series has further advanced, leading to greater visibility and usability. Iconized features and operation menus are easy to recognize, and readily available for anyone to use. The Simple Monitor screen displays the information required for lathes and machining centers respectively in an enlarged view. The icons on the screen tell you the status of tools and spindles. All of these interface features are worth a try.

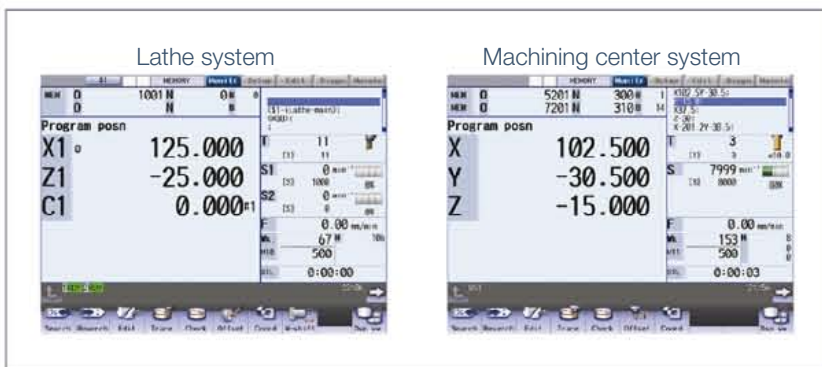

Simple screen with narrowed-down information is easy to see from a distance.

Usability in lathe improved through tool icons, 3D work simulation for turning and other dedicated features

One of the highlights in M800/M80 Series is improved usability in a lathe. The tool icons indicate the tool shape and bit direction in an easy manner, which can satisfy both inexperienced and experienced operators. The 3D graphic check supports for both turning and milling, so even a complex program can easily be checked through the 3D simulation.

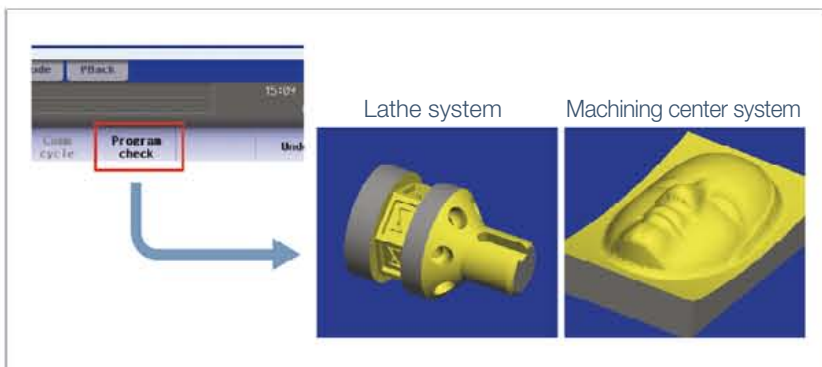

A click of the menu button navigates you to 3D graphic check of the currently edited program. For lathe system, the 3D check supports for both milling and turning.

Reducing leakage of defects caused by human errors

M800/M80 Series has a feature called "User level-based data protection", which allows you to set multiple levels of access permission. Permissible operation range can be set for each operator according to their roles in production. This can ever more effectively prevent operation errors and other human errors, resulting in less defect leakage.

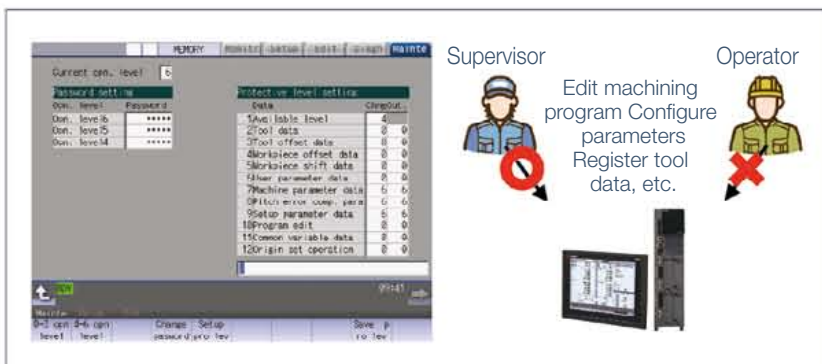

Up to 8 levels of access permission helps to prevent you from dispatching defective works. Permissible operation can be set individually for each access level.

CNC LINEUP

High Performance



M800W



Premium CNC with Windows-based display provides expandability and flexibility

- Separated type, a control unit separated from display
- Display with Windows offers excellent expandability
- Four expansion slots are provided as standard specifications, allowing for expansion using option cards

M800S



High-grade CNC well suited to high-speed high-accuracy machining and multi-axis multi-part system control

- Panel-in type, a control unit with integrated display
- Multi-CPU architecture allows for high performance and high functional graphics
- Windows-less display provides easy operability

M80W



Standard CNC with expandability and flexibility

- Separated type, a control unit separated from display
- Packaged type for selecting a machine type easily
- Windows-based display offers excellent expandability
- Two expansion slots are provided as standard specifications, allowing for expansion using option cards

M80



Standard CNC provides high productivity and easy operability

- Panel-in type, a control unit with integrated display
- Provided in package (TypeA/TypeB) for easier selection
- Windows-less display provides easy operability

Standard

Display unit size

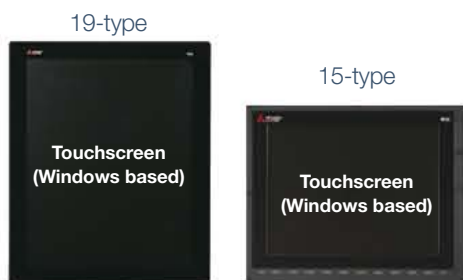
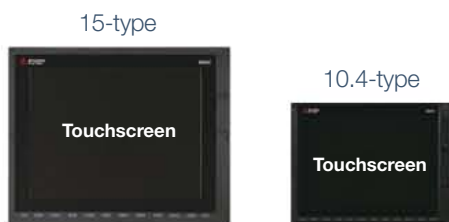
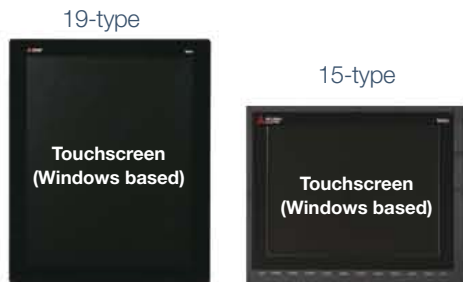

Main Specifications

	Lathe system	Machining center system
Max. number of axes (NC axes + Spindles + PLC axes)	Standard: 16 Optional: 32	
Max. number of spindles	8	4
Max. number of part systems (main+sub)	Standard: 4 Optional: 8	2
Fine segment processing capacity [kilo-blocks/min]	168	270

	Lathe system	Machining center system
Max. number of axes (NC axes + Spindles + PLC axes)	Standard: 16 Optional: 32	
Max. number of spindles	8	4
Max. number of part systems (main+sub)	Standard: 4 Optional: 8	2
Fine segment processing capacity [kilo-blocks/min]	168	270

	Lathe system	Machining center system
Max. number of axes (NC axes + Spindles + PLC axes)	12	11
Max. number of spindles	4+G/B ^(*1)	2
Max. number of part systems (main+sub)	4	2
Fine segment processing capacity [kilo-blocks/min]	67.5	135

	Lathe system	Machining center system
Max. number of axes (NC axes + Spindles + PLC axes)	TypeA: 12 TypeB: 9	TypeA: 11 TypeB: 9
Max. number of spindles	TypeA: 4+G/B ^(*1) TypeB: 3	2
Max. number of part systems (main+sub)	TypeA: 4 TypeB: 2	TypeA: 2 TypeB: 1
Fine segment processing capacity [kilo-blocks/min]	TypeA: 67.5 TypeB: -	TypeA: 135 TypeB: 16.8

(*1) G/B: Guide Bush

SYSTEM CONFIGURATIONS

Ethernet

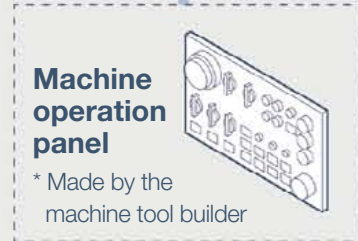
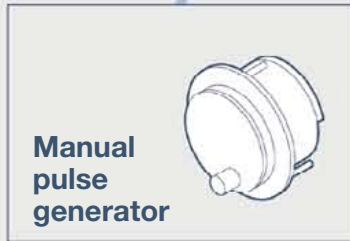
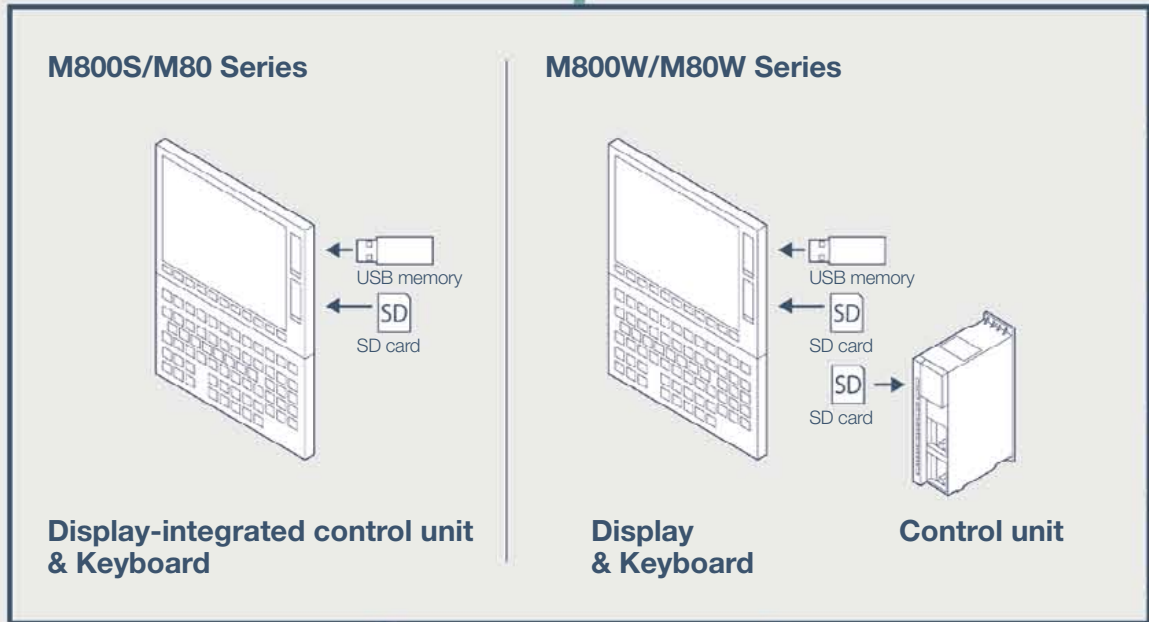

This CNC makes it easier to configure factory automation systems, and design and build machine tools

- Compatible with a range of field networks, facilitating connection with peripherals to configure factory automation systems
- Compatible with MES interface function, through which the CNC automatically sends data to the production control system database upon completion of cutting or occurrence of alarm. This enables more efficient configuration of production or quality control systems.
- I/O units have been redesigned. The units can be mounted on DIN rails, and the lineup has been expanded with improved built-in PLC functionality for I/O control.
- Software tools have been upgraded, and now support everything from designing to setting up machine tools. These tools simplify design processes and building machine tools.

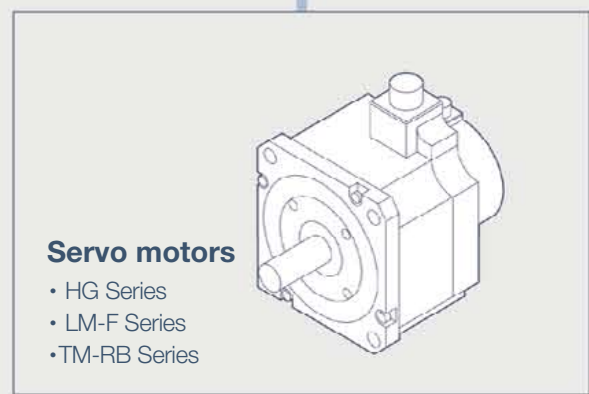

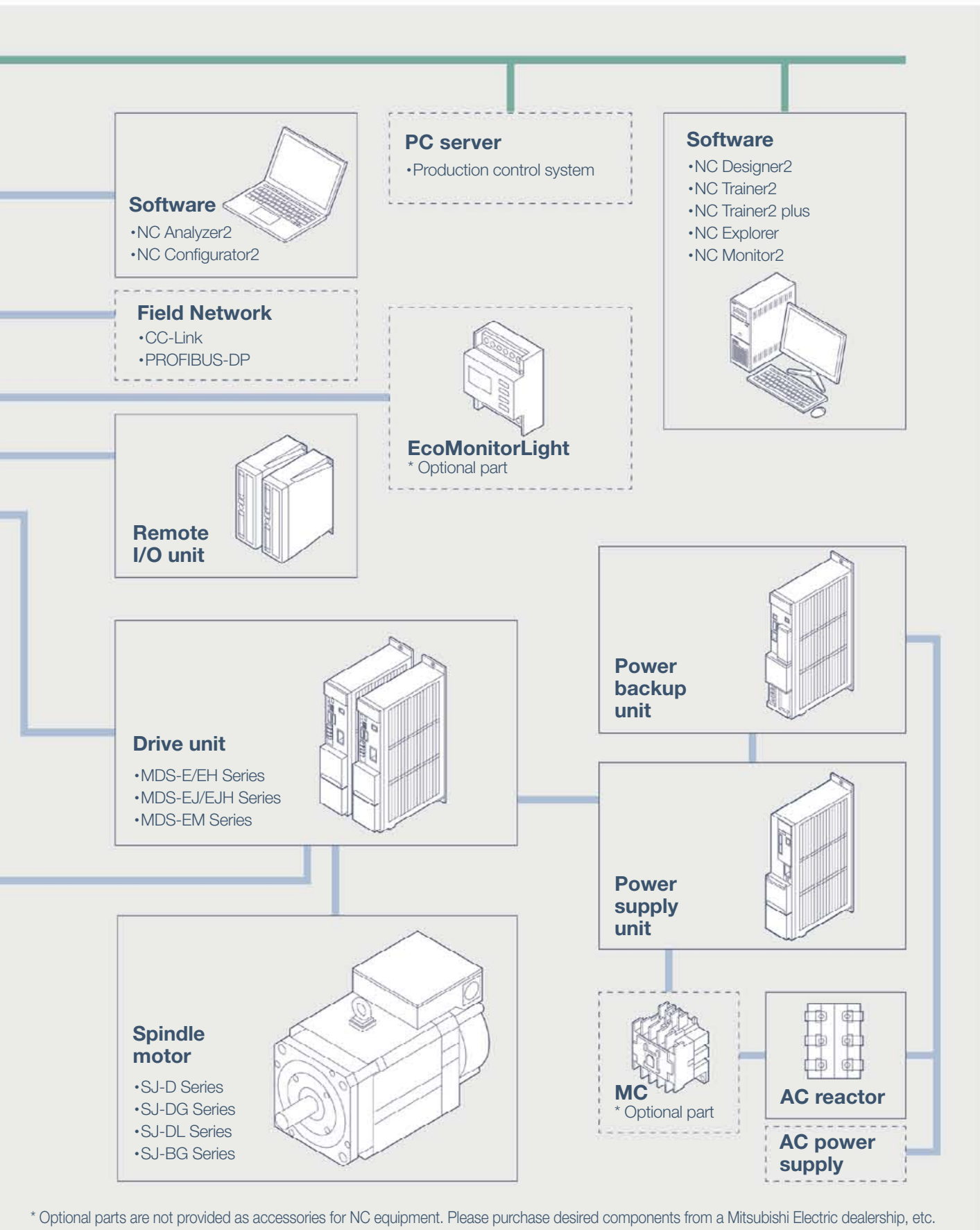

* Optional parts are not provided as accessories for NC equipment. Please purchase desired components from a Mitsubishi Electric dealership, etc.

ENHANCED LATHE SYSTEM

Milling features and multi-axis, multi-part system control features have been significantly improved. Progress has been made in operability, enabling operators to implement ever more complex machining in an easy and efficient manner.

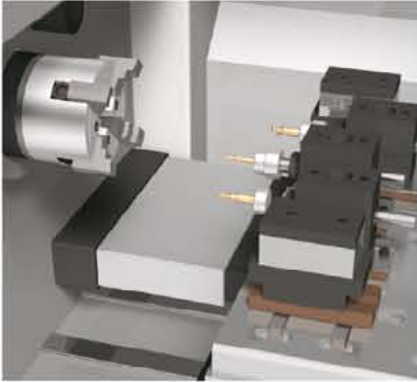

Lathe

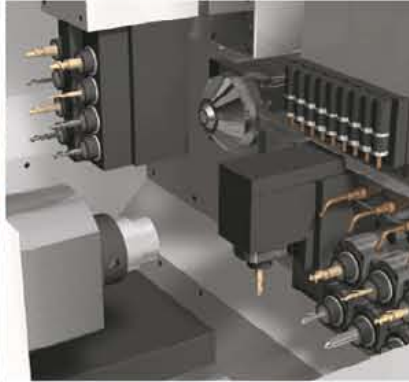

Automatic lathe

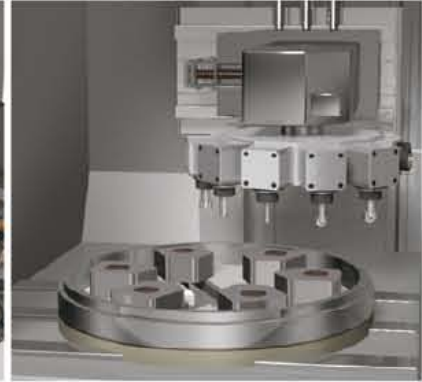

Vertical lathe



Inverted lathe

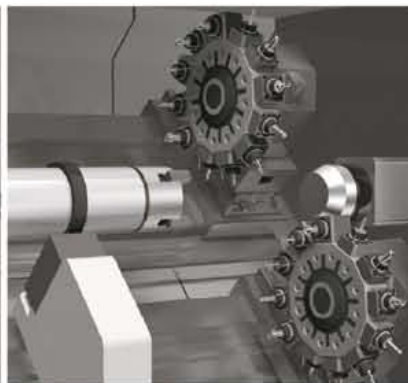

Multi-tasking lathe

Milling features

High-speed high-accuracy control
 Super Smooth Surface (SSS) control
 Spindle-mode servo motor control

Multi-axis, multi-part system control features

Supports up to 8 part systems, 32 axes and 8 spindles
 Loader control via sub-part system control
 Spindle superimposition control
 Multiple spindle synchronization set control

Features for large-sized lathes

Re-thread cutting
 Thread cutting override
 Real-time tuning
 Large-sized display

User operability

Workpiece coordinate system shift
 Easy setup of barrier check parameters
 Simple monitor screen showing narrowed-down information

Conversational programming

Program edit with timing synchronization between part systems
 Interactive cycle insertion
 3D program check

Implement ever more complex machining in an easy and efficient manner

Milling features have been improved through high-speed high-accuracy control and SSS control. Multi-axis, multi-part system control features have also been upgraded. A wide array of these features help ensure high productivity.

Significant progress has also been made in frequently used operation as well as programming, such as tool offset and workpiece coordinate system shift, which allows operators to easily implement ever more complex machining.



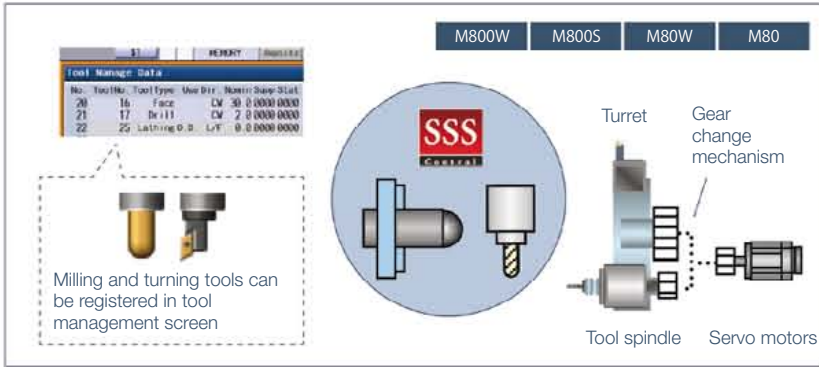

High-speed high-accuracy control and SSS control are available for milling using lathe system. A servo motor driven by a servo drive unit can be controlled as a tool spindle.

Improved milling features using a tool spindle

High-speed high-accuracy control features accumulated originally for machining centers are now available in lathe system. Fine milling can be implemented at high speeds on a lathe.

This CNC enables a servo motor, instead of a spindle, to act as a tool spindle. Any of the servo control axes driven by multi-hybrid drive can be used as a tool spindle. This contributes to the downsizing of machine tools.

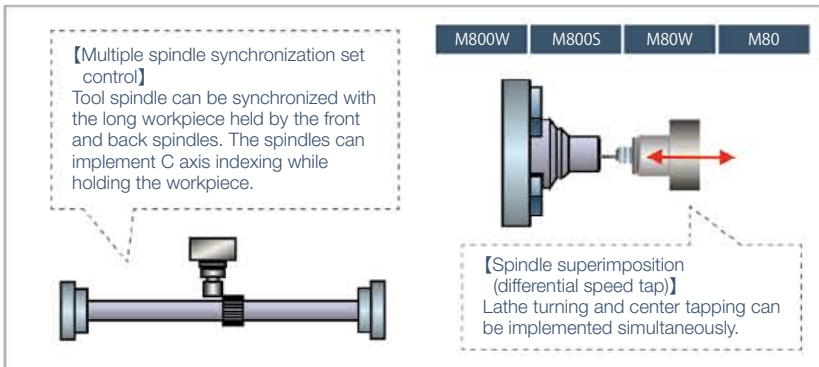

M800 Series controls up to 8 part systems, 32 axes and 8 spindles. This CNC provides the advanced multi-axis, multi-part system control features including loader control using sub-part system, spindle superimposition and synchronization of multiple spindle sets.

Multi-axis multi-part system control features help to reduce cycle time and maintain synchronization between part systems

M800/M80 Series provides "Spindle superimposition control," a feature that enables simultaneous execution of turning and center tapping, although they needed to be executed individually.

These features are effective in eliminating idle time, resulting in a significant reduction in tact time.

This CNC also offers features that maintain synchronization between part systems, which is required for automatic lathes, in particular. These enable operators to implement ever more complex machining safely and securely.

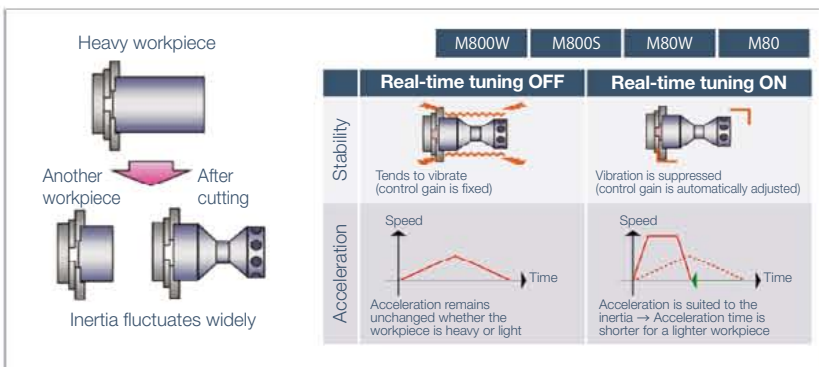

Real-time tuning helps maintain the stability of large lathes. This function detects vibration caused by significant fluctuation of work inertia and automatically adjusts the control gain.



Conversational programming, tool measurement, work coordinate system shift and other features have been improved, making the lathe system significantly easier to use.

Significantly easier programming

Programming has been made much easier: program edit screen shows the synchronization points between part systems in an easy-to-understand display, and conversational programming allows insertion of canned cycles. After programming, operators can check the programs through 3D work simulation before actual cutting.

ENHANCED MACHINING CENTER SYSTEM

SSS control has further evolved, realizing high-speed, high-accuracy, high-quality machining. In addition, this CNC offers features that bring out the full potential of each axis and minimize non-cutting time, leading to higher productivity.



Vertical machining center



Tapping center



Horizontal machining center

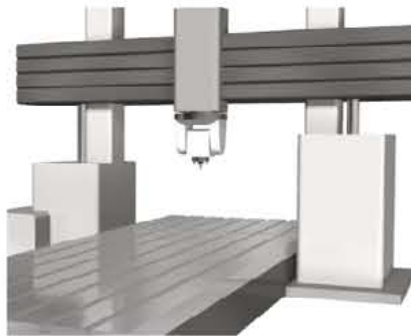

Gantry-type machining center

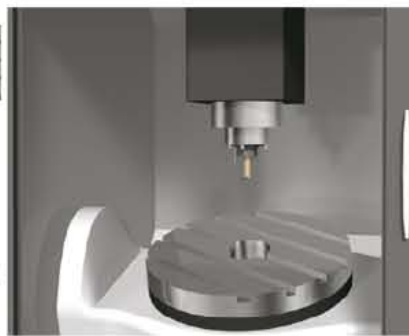

5-axis control machine

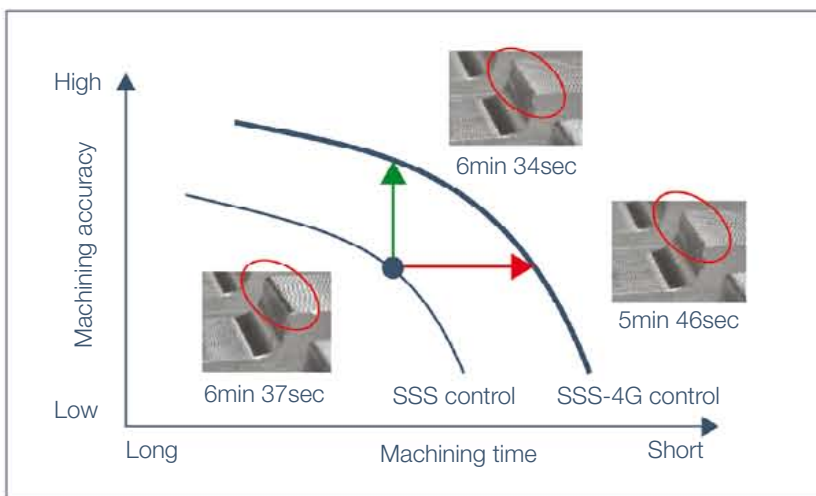

High-speed, high-accuracy, high-quality cutting through SSS-4G control

M800/M80 Series offers SSS 4th-generation (SSS-4G) control, enabling high-speed, high-accuracy, high-quality machining. SSS-4G control provides features that are effective in reducing tact time, including optimal acceleration/deceleration suited to each axis' characteristics. In addition, SSS-4G is capable of reducing machine vibration during high-speed cutting.

SSS-4G control allows for greater cutting accuracy in the same length of time, or shorter cutting time with the same degree of accuracy when compared to our previous models.



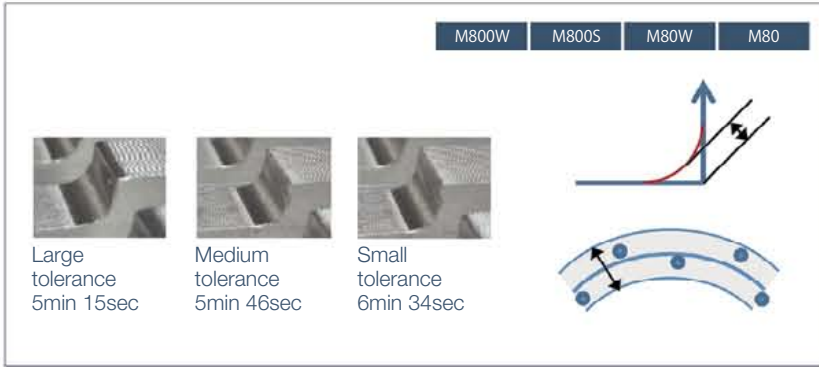

Tolerance control function provides a smooth motion within specified error tolerances. Desired machining results can be achieved using simple parameter adjustment.

High productivity and high quality are our primary focus

CNC-dedicated CPU is incorporated in the M800/M80 Series, providing significantly improved short segment processing capability. The benefits are not limited to improvements in basic performance alone. The Tolerance Control function enables operators to achieve high-quality surfaces simply by specifying the desired dimensional accuracy. This feature takes machining to a whole new level.



"Variable-acceleration pre-interpolation acceleration/deceleration" optimizes the acceleration in accordance with the axis motion.

M800/M80 Series brings out the full potential of machine tools

M800/M80 Series provides new features that can maximize the full potential of machine tools, including: Variable-acceleration pre-interpolation acceleration/deceleration provides optimized acceleration, with each axis' characteristics fully exercised. For example, allowing a linear axis to accelerate irrespective of rotary axis responsiveness.

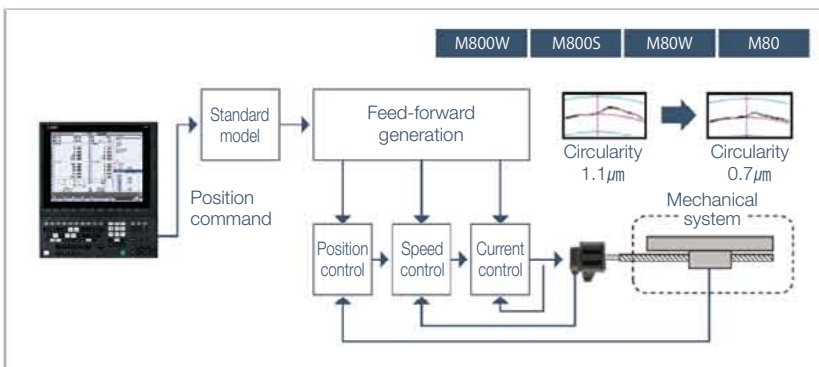

"OMR-FF control" makes servo control smoother and more accurate, enabling optimal position loop gain adjustment suited to each axis.

"OMR-FF control" allows for optimal position loop gain adjustment suited to each axis, leading to smoother and more accurate cutting.

Other than the above, this CNC has new functionality effective for higher productivity, including "Rapid traverse block override function" that helps reduce non-cutting time by overlapping feed blocks.

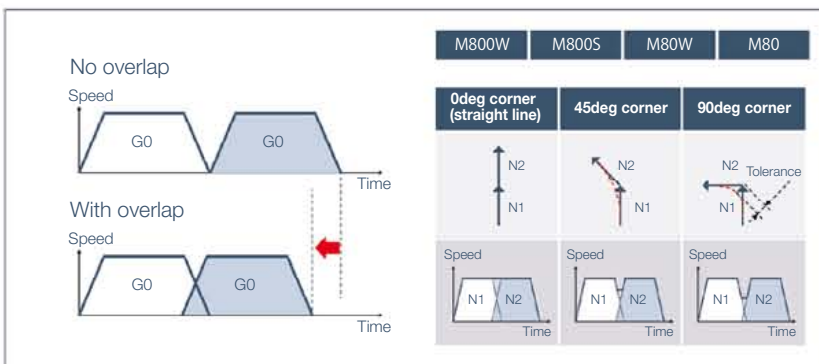

Rapid traverse block overlap function makes it possible to reduce non-cutting time. The overlap varies according to the path to keep the tolerance constant.

Necessary features are available on your machine. M80 Series includes SSS control and inclined surface machining features.

The SSS control function provides smoother surfaces at higher speeds and the inclined surface machining control function makes it possible to issue normal program commands to an arbitrary plane (inclined surface) in space. These and various other features are incorporated in the M80 Series.

UNIQUE CUSTOMIZATION

A high level of screen customization is attainable more easily in a shorter period of time.

Highly scalable hardware and advanced drawing application make it possible to increase the added value of machine tools.



M800W/M80W Series is equipped with a 19-type vertical display with a two-split multi-window screen.

Home application in the lower half can freely be customized.

19-type vertical display boosts the added value of machine tools

The display shows the standard CNC screen on the upper half, while offering the lower half (home application) to be freely customized. It is also possible to add some originality to machines to increase their added value. However, it is difficult to design the whole screen at the same time. This screen layout can satisfy such needs.

Combined with customers' ideas, the possibilities are infinite.

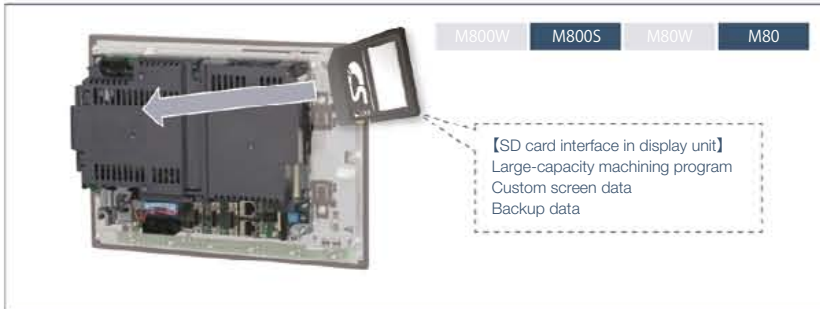

Additional SD memory card interface on backside of display.

An SD card can store large-capacity machining programs and custom screen data.

Support for large-capacity custom data using the SD memory on the back of display

The panel-in type CNC with integrated display has the SD card interface on the back of the display.

SD card can accommodate large-capacity machining programs, and large-capacity graphic data for custom screens, which leads to increased possibilities of customization.

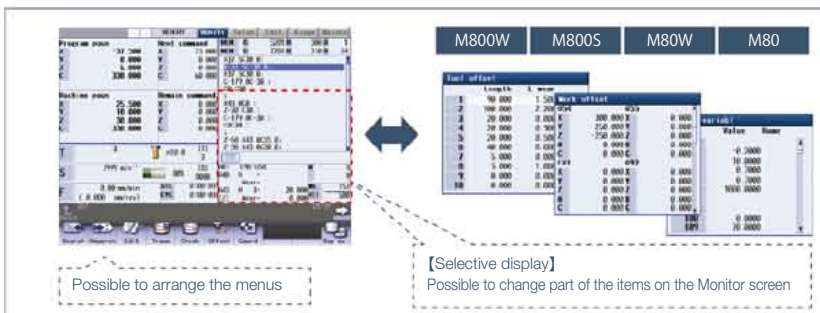

Standard screens can be customized using the selective display and rearranging menus. Screens matching operators' preferences and needs enable even greater ease of use.

Customize the standard screens as per the preference of operators

Each operator has their own set of frequently used menus. This CNC allows operators to rearrange their menus and hide any unused ones so they can easily navigate to their desired screen.

This CNC has a function called Selective Display, which enables partial customization of the Monitor screen. Operators can constantly view and monitor Tool offset, Work offset, Common variable or other commonly used functions.

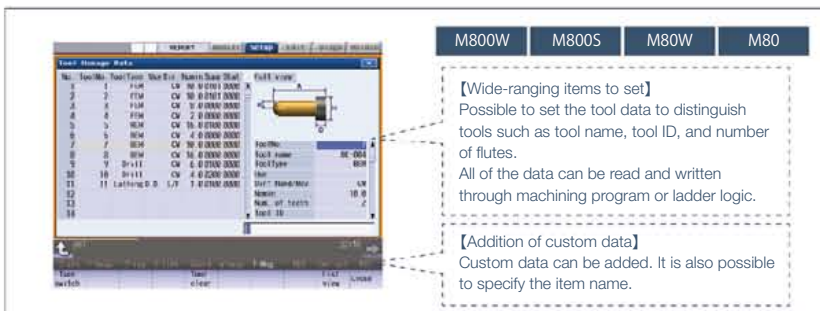

Tool-related information is collected and centrally managed on the Tool Management Screen.

A wide range of setting items such as tool name and tool ID are readily available.

It is also possible to add custom data.

REINFORCED FUNCTIONAL SAFETY

M800/M80 Series provides a range of safety features collectively called the Smart Safety Observation Function. This function has achieved full conformity with the safety standards that cover the entire system including CNC, drive, I/O, sensors and communication.

Smart safety observation function

- | | |
|--|-------------------------------|
| Safety-related I/O observation | Emergency stop observation |
| Safely-Limited Speed (SLS) | Safely-Limited Position (SLP) |
| Safe Operating Stop (SOS) | Safe Speed Monitor (SSM) |
| Safe Brake Control/Safe Brake Test (SBC/SBT) | Safe Cam (SCA) |
| Safe Stop (SS1/SS2) | Safe Torque Off (STO) |

Functional safety system can be configured easily.

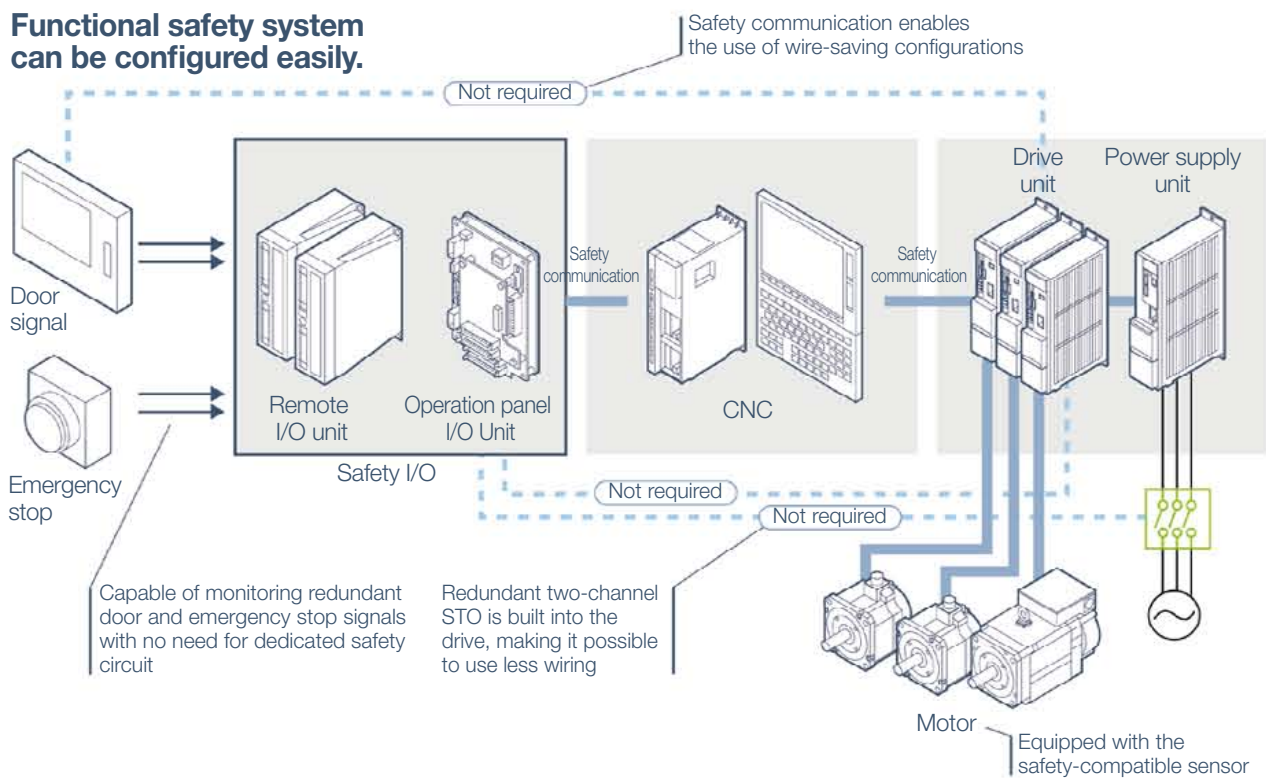

Compliant with a range of safety standards, equipped with the drive safety features required for machine tools

The Smart Safety Observation Function conforms to EC Machinery Directive (2006/42/EC) and meets the following safety standard requirements. The function has also obtained the Type Approval Certificate from TÜV SÜD (German certification authority) with regard to the conformity with the safety standards.



Type Approved Safety
Regular Production Surveillance
www.tuv.com
ID 2000000000

【Compatible functional/product safety standards】

- EN ISO 13849-1 : 2008 (PLd, Cat.3) •IEC 61508-1~3 : 2010 (SIL 2) •EN 62061 : 2005 (SIL CL 2)
- EN 61800-5-1 : 2007 •EN 60204-1 : 2006

SUPPORT FOR AUTOMATION ENHANCED TRACEABILITY

Supports automation needs
Connectable to a range of field networks

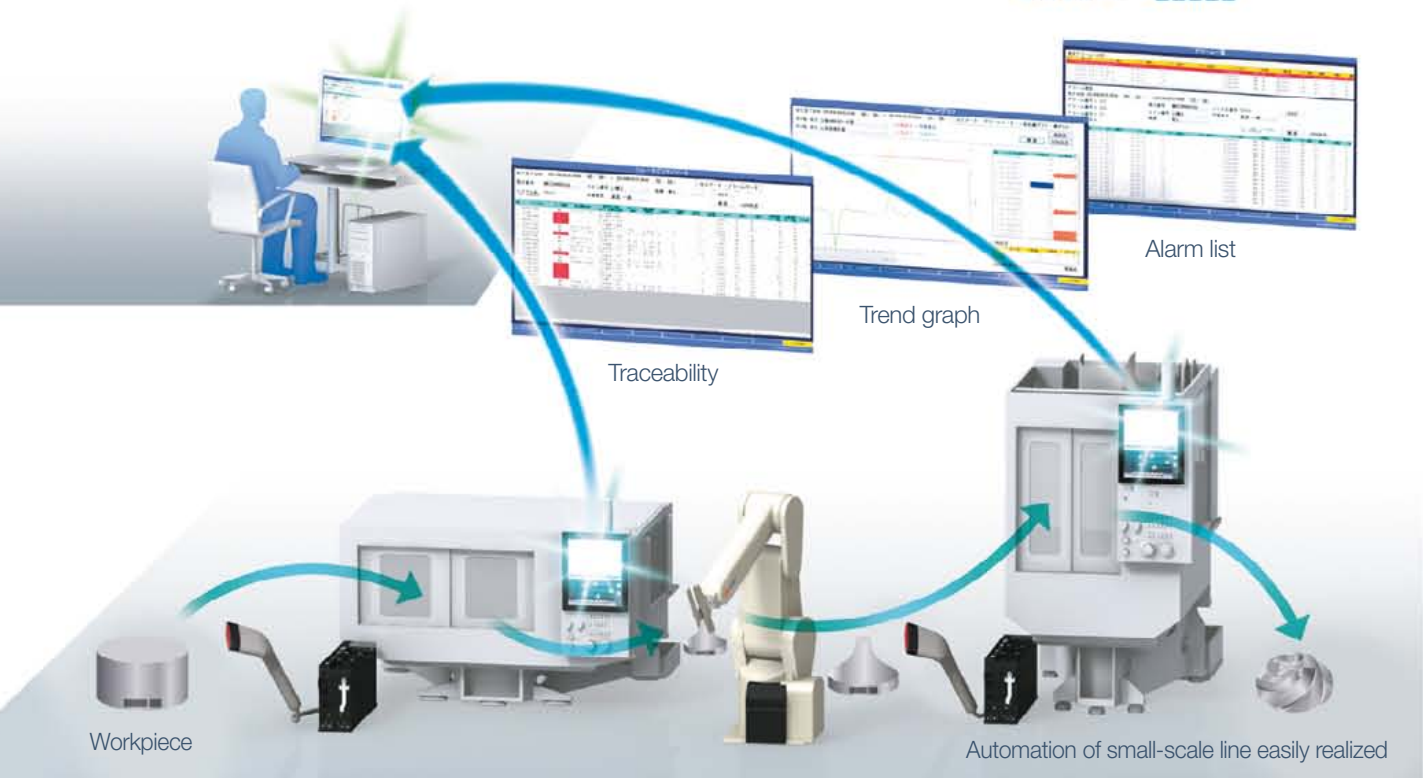

Needs for automation are increasing, which can be realized more easily with lower cost.

Improved traceability helps to visualize factory-wide operation

M800/M80 Series CNCs are equipped with the MES interface function, through which the CNC automatically sends SQL statements to the production control system database upon completion of cutting or occurrence of an alarm. This can significantly increase traceability throughout the factory. This transparency helps optimize production planning and management.

Quality control can also be easier through visualization of alarm history and the production results based on the basic unit specific to each workpiece.

In addition, when control is combined with the EcoMonitorLight power consumption monitor, operators can monitor not only CNC status, but also the energy consumed by the machines.

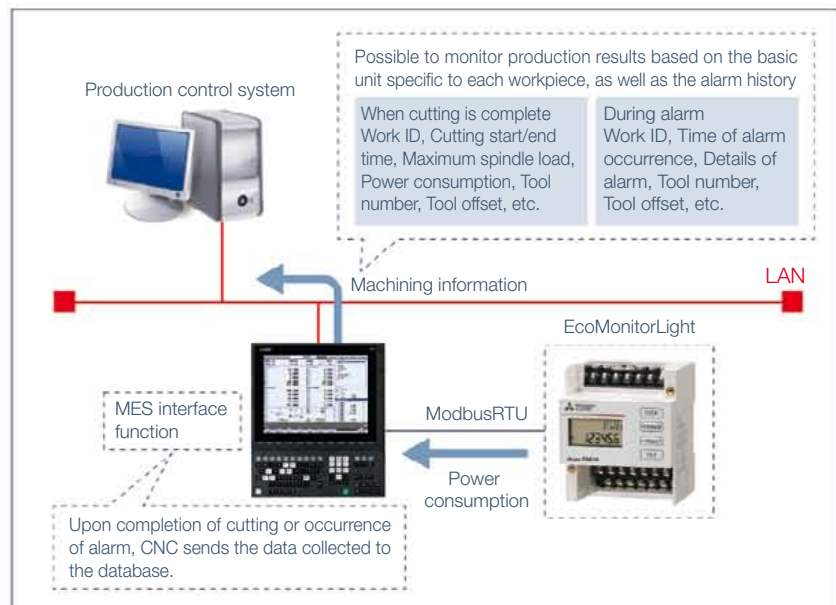

Needs for automation are increasing, which can be realized more easily and with lower cost.

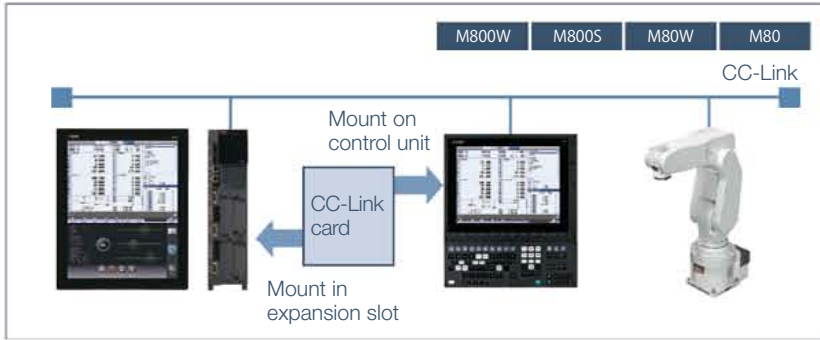

Compatible with CC-Link (master/slave), PROFIBUS-DP (master). Possible to connect to peripheral equipment and devices conforming to a range of field networks.

Compatible with a range of field networks that facilitate connection to peripheral equipment

With the aim of configuring factory automation systems, compatibility with a range of field networks has been implemented, enabling connection to peripheral equipment and devices. Insert the option card into the standard expansion slot of the M800W/M80W Series CNC or on the back side of the display for the M800S/M80 Series.

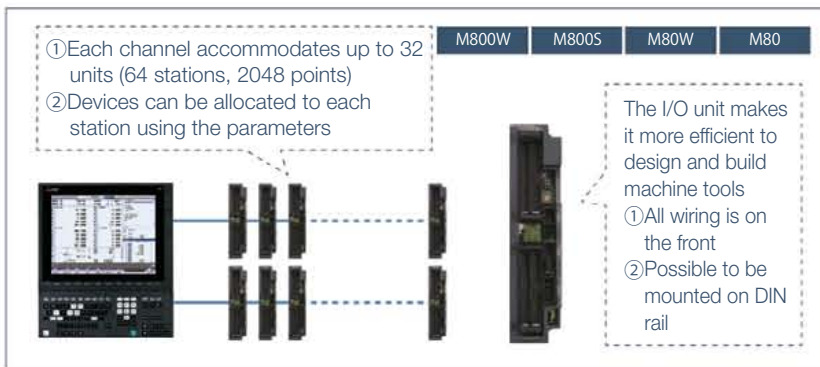

Renewed I/O communication method allows for the control of up to 64 stations and 2,048 points per channel. Various peripheral equipment can be controlled by the CNC alone.

Renewed I/O units and built-in PLC functionality make it easier to control and manage peripheral equipment

I/O units have been redesigned. The renewed I/O communication method makes it possible to significantly increase the maximum number of contact points per channel, enabling a number of peripheral equipment and devices to be controlled by CNC alone. In addition, built-in PLC functionality for I/O control has been improved. This CNC supports Multi-project PLC, a feature that enables ladder logics for peripheral equipment to be managed separately from those for machine tools. This creates a more efficient environment for operators working together in developing and managing ladder logics.

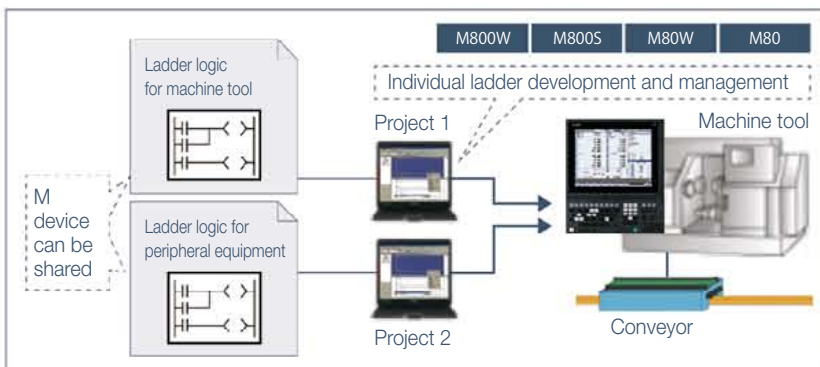

Multi-project PLC enables control of ladder logic for peripheral equipment separately from that for machine tools. This leads to efficient development and management of ladder logics for peripheral equipment.

New feature capable of stopping peripheral equipment incorporated

M800/M80 Series has a feature called Machine Group-based Alarm Stop, which stops operation of individual machine groups if an alarm occurs when control is combined with the MDS-E/EM/EJ Series.

This feature allows continuation of machining even when an alarm occurs on a loader, magazine or other peripheral equipment.

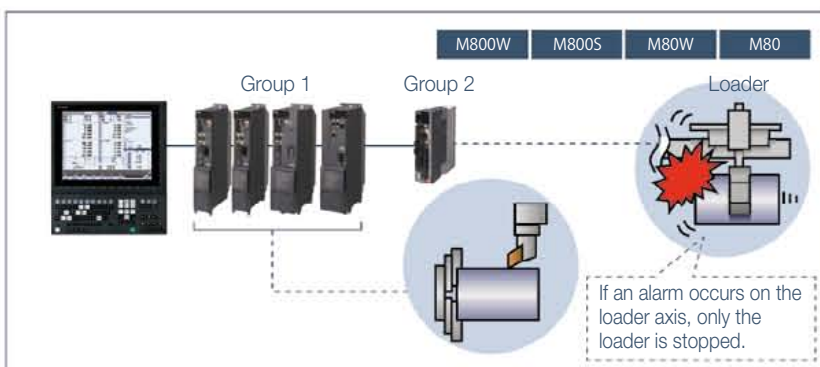

During an alarm, operation of individual machine groups can be stopped. Machining is not interrupted when an alarm occurs on peripheral equipment (e.g., loader).

EXCELLENT MAINTAINABILITY

The number of spare parts for M800/M80 Series CNCs has been reduced, environmental resistance improved and assembly simplified to provide higher efficiency in maintenance.

Control unit



M800W

M80W



M800S



M80

- No-fan structure
- Heat generation suppressed by introducing an original CPU
 - Spare parts reduced

- ECC-embedded memory
- Memory error detection and correction possible with built-in ECC
 - Noise tolerance improved

Display unit



Display panel

- Capacitive touch-screen panel
- Easy operation and longer service life

- Separated front I/F ports
- Protect the SD card slot from any fluid even while a USB memory device is inserted



Personal computer unit
(M800W/M80W Series)

- No hard-disk drive
- Vibration resistance improved

I/O unit









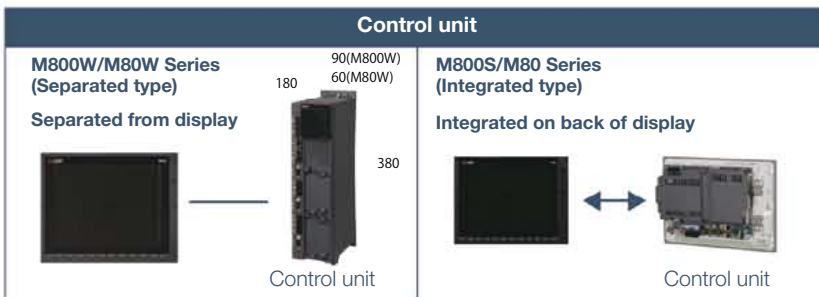







- Front-side wiring
- All wiring can be done from the front side of the unit
 - Assembly simplified

- DIN rail mount
- All types are mountable on DIN rails
(can also be attached using screws)

HARDWARE



Display	Keyboard	M800W Series	M800S Series	M80W Series	M80 Series
19-type Touchscreen	—	 <p>365 440</p>	—	 <p>365 440</p>	—
15-type Touchscreen	FCU8-KB083 Clear key Full keyboard	 <p>400 320 140</p>	 <p>400 320 140</p>	 <p>400 320 140</p>	 <p>400 320 140</p>
10.4-type Touchscreen	FCU8-KB047 Clear key Full keyboard	—	 <p>290 220 160</p>	—	 <p>290 220 160</p>
10.4-type Touchscreen	FCU8-KB041 Clear key ONG(XZF) layout for L system FCU8-KB046 Clear key ONG(XYZ) layout	—	 <p>290 140 220</p>	—	 <p>290 140 220</p>
10.4-type Touchscreen	FCU8-KB048 Clear key ABC layout	—	 <p>290 230 220</p>	—	 <p>290 230 220</p>
8.4-type	FCU8-KB026 Clear key ONG(XYZ) layout FCU8-KB028 Clear key ONG(XYZ) layout	—	—	—	 <p>260 140 200</p>
8.4-type	FCU8-KB029 Clear key ONG layout	—	—	—	 <p>260 200 140</p>

SPECIFICATIONS

○Standard △Optional □Selection

		Lathe system						
		M800W Series		M800S Series		M80W Series	M80 Series	
		M850W	M830W	M850S	M830S		TypeA	TypeB
Number of control axes	Max. number of axes (NC axes + Spindles + PLC axes)	○16 △32	○16 △32	○16 △32	○16 △32	12	12	9
	Max. number of NC axes (in total for all part systems)	○16 △32	○16 △32	○16 △32	○16 △32	10	10	7
	Max. number of spindles	8	8	8	8	4+G/B ^{(*)1}	4+G/B ^{(*)1}	3
	Max. number of PLC axes	8	8	8	8	6	6	6
	Number of simultaneous contouring control axes	8	4	8	4	4	4	4
	Max. number of NC axes in a part system	8	8	8	8	8	8	5
Max. number of part systems (main+sub)		○4 △8	○4 △8	○4 △8	○4 △8	4	4	2
Max. number of main part systems		○4 △8	○4 △8	○4 △8	○4 △8	2	2	2
Max. number of PLC indexing axes		○4 △8	○4 △8	○4 △8	○4 △8	2	2	1
Control unit-side High-speed program server mode		△	△	—	—	○	—	—
Display unit-side High-speed program server mode		△	△	△	△	○	○	○
Front-side SD card mode		○	○	○	○	○	○	○
Least command increment		○0.1μm △1nm	○0.1μm △1nm	○0.1μm △1nm	○0.1μm △1nm	0.1μm	0.1μm	0.1μm
Least control increment		1nm	1nm	1nm	1nm	1nm	1nm	1nm
Max. number of tool offset sets		○128 sets △999 sets	○128 sets △999 sets	○128 sets △999 sets	○128 sets △999 sets	256 sets	256 sets	99 sets
Max. PLC program memory capacity [steps]		○128000 △512000	○128000 △512000	○128000 △512000	○128000 △512000	64000	64000	32000
Multi-project PLC (max. number of projects)		○1 △6	○1 △6	○1 △6	○1 △6	3	3	1
Touch gesture operation ^{(*)2}		○	○	○	○	○	○	○
User level-based protection		△	△	△	△	○	○	○
Workpiece coordinate system shift		○	○	○	○	○	○	○
3D program check		○	○	○	○	○	○	○
Interactive cycle insertion		△	△	△	△	○	○	○
Multiple spindle synchronization set control		○	○	○	○	○	○	○
Spindle superimposition control		△	△	△	△	○	○	—
High-accuracy control		△	△	△	△	○	○	—
High-speed high-accuracy control I		△	△	△	△	○	○	—
High-speed high-accuracy control II		△	△	△	△	○	○	—
SSS control		△	△	△	△	○	○	—
Tolerance control		△	△	△	△	○	○	—
Variable-acceleration pre-interpolation acceleration/deceleration		—	—	—	—	—	—	—
OMR-FF control		△	△	△	△	○	○	—
Rapid traverse block overlap		△	△	△	△	○	○	○
Spindle-mode servo motor control		△	△	△	△	○	○	○
Real-time tuning 1 (speed gain changeover)		△	△	△	△	○	○	—
Real-time tuning 2 (rapid traverse time constant changeover)		△	△	△	△	○	○	—
Tool center point control		—	—	—	—	—	—	—
Inclined surface machining command		—	—	—	—	—	—	—
3-dimensional manual feed		△	△	△	△	○	○	—
R-Navi		—	—	—	—	—	—	—
CC-Link (Master/Slave)		□	□	□	□	□	□	□
PROFIBUS-DP (Master)		□	□	□	□	□	□	□
MES interface function		△	△	△	△	○	○	○
EcoMonitorLight connection		○	○	○	○	○	○	○
Machine group-based alarm stop		△	△	△	△	○	○	○
Smart safety observation		△	△	△	△	○	□	□

SPECIFICATIONS

○Standard △Optional □Selection

		Machining center system						
		M800W Series		M800S Series		M80W Series	M80 Series	
		M850W	M830W	M850S	M830S		TypeA	TypeB
Number of control axes	Max. number of axes (NC axes + Spindles + PLC axes)	○16 △32	○16 △32	○16 △32	○16 △32	11	11	9
	Max. number of NC axes (in total for all part systems)	16	16	16	16	8	8	5
	Max. number of spindles	4	4	4	4	2	2	2
	Max. number of PLC axes	8	8	8	8	6	6	6
	Number of simultaneous contouring control axes	8	4	8	4	4	4	4
	Max. number of NC axes in a part system	8	8	8	8	8	8	5
Max. number of part systems (main+sub)		2	2	2	2	2	2	1
Max. number of main part systems		2	2	2	2	2	2	1
Max. number of PLC indexing axes		2	2	2	2	—	—	—
Control unit-side High-speed program server mode		△	△	—	—	○	—	—
Display unit-side High-speed program server mode		△	△	△	△	○	○	○
Front-side SD card mode		○	○	○	○	○	○	○
Least command increment		○0.1μm △1nm	○0.1μm △1nm	○0.1μm △1nm	○0.1μm △1nm	0.1μm	0.1μm	0.1μm
Least control increment		1nm	1nm	1nm	1nm	1nm	1nm	1nm
Max. number of tool offset sets		○200 sets △999 sets	○200 sets △999 sets	○200 sets △999 sets	○200 sets △999 sets	400 sets	400 sets	400 sets
Max. PLC program memory capacity [steps]		○128000 △512000	○128000 △512000	○128000 △512000	○128000 △512000	64000	64000	32000
Multi-project PLC (max. number of projects)		○1 △6	○1 △6	○1 △6	○1 △6	3	3	1
Touch gesture operation		○	○	○	○	○	○	○
User level-based protection		△	△	△	△	○	○	○
Workpiece coordinate system shift		—	—	—	—	—	—	—
3D program check		○	○	○	○	○	○	○
Interactive cycle insertion		—	—	—	—	—	—	—
Multiple spindle synchronization set control		—	—	—	—	—	—	—
Spindle superimposition control		—	—	—	—	—	—	—
High-accuracy control		△	△	△	△	○	○	○
High-speed high-accuracy control I		△	△	△	△	○	○	○
High-speed high-accuracy control II		△	△	△	△	○	○	—
SSS control		△	△	△	△	○	○	○
Tolerance control		△	△	△	△	○	○	○
Variable-acceleration pre-interpolation acceleration/deceleration		△	△	△	△	—	—	—
OMR-FF control		△	△	△	△	○	○	○
Rapid traverse block overlap		△	△	△	△	○	○	○
Spindle-mode servo motor control		△	△	△	△	○	○	○
Real-time tuning 1 (speed gain changeover)		△	△	△	△	○	○	—
Real-time tuning 2 (rapid traverse time constant changeover)		△	△	△	△	○	○	—
Tool center point control		△	△	△	△	○	○	—
Inclined surface machining command		△	△	△	△	○	○	—
3-dimensional manual feed		△	△	△	△	○	○	—
R-Navi		△	△	△	△	○	○	—
CC-Link (Master/Slave)		□	□	□	□	□	□	□
PROFIBUS-DP (Master)		□	□	□	□	□	□	□
MES interface function		△	△	△	△	○	○	○
EcoMonitorLight connection		○	○	○	○	○	○	○
Machine group-based alarm stop		△	△	△	△	○	○	○
Smart safety observation		△	△	△	△	○	□	□

Refer to the specifications manuals for details.

(*1)G/B:Guide Bush

(*2)The 8.4-type display unit is incompatible.

DRIVE SYSTEM

Drive unit



High-performance Servo/Spindle Drive Units MDS-E/EH Series

- The servo control-dedicated core processor realizes an increase in control speed, leading to improved basic performance. When combined with a higher resolution motor sensor and enhanced high-speed optical communication, this drive contributes to high-speed, high-accuracy control.
- Motor power connector comprises an anti-misinsertion mechanism. This helps to eliminate connection errors.
- Improved diagnostic and preventive-maintenance features.
- Safe Torque Off (STO) and Safe Brake Control (SBC) are supported in effort to enhance safety features.



Multi-hybrid Drive Units MDS-EM Series

- The multi-hybrid drive unit is capable of driving a maximum of three servo axes and one spindle. This contributes to the downsizing of machines and offers technical advantages.
- Motor power connector comprises an anti-misinsertion mechanism. This helps to eliminate connection errors.
- Safe Torque Off (STO) and Safe Brake Control (SBC) are supported in effort to enhance safety features.



All-in-one compact drive units MDS-EJ/EJH Series

- Ultra-compact drive units with built-in power supplies contribute to reduced control panel size.
- The servo control-dedicated core processor realizes an increase in control speed, leading to improved basic performance. When combined with a higher resolution motor sensor and enhanced high-speed optical communication, this drive contributes to high-speed, high-accuracy control.
- Safe Torque Off (STO) and Safe Brake Control (SBC) are supported in effort to enhance safety features.
- MDS-EJH 400V system drive unit is available (Note 1).

Servo motors



Medium-inertia, high-accuracy and high-speed motors HG Series

- Sensor resolution has been significantly improved. The servo motors, which boast smooth rotation and outstanding acceleration capabilities, are well-suited to serve as feed axes of machine tools.
- Range 0.2 to 9 [kW]
- Maximum speed: 4,000 or 5,000 [r/min]
- Safety support sensors are included as standard specification. Sensor connectors are screw-locked and have enhanced vibration resistance. Three sensor resolutions (i.e., 1, 4 and 67 million pulses/rev) are available.



Linear Servo Motor LM-F Series

- Use in clean environments is possible since no ball screws are used, eliminating possible contamination from grease.
- Elimination of transmission mechanisms, including backlash, enables smooth and quiet operation even at high speeds.
- Dimensions:
Length: 170 to 1,010 [mm]
Width: 120 to 240 [mm]



Direct Drive Servo Motor TM-RB Series

- High-torque, direct-drive motor combined with high-gain control provides quick acceleration and positioning, which makes rotation smoother.
- Suitable for rotary axes that drive tables or spindle heads.
- Range:
Maximum torque: 36 to 1,280 [N·m]

Spindle motor



High-performance Spindle Motor SJ-D Series

- Motor energy loss has been significantly reduced by optimizing the magnetic circuit.
- High-speed bearing incorporated as a standard feature helps to achieve higher speed, lower vibration and improved durability.
- Range:
Normal SJ-D Series 3.7 to 11 [kW]
Compact & light SJ-DJ Series 5.5 to 15 [kW]
- Maximum speed 10,000 or 12,000 [r/min]

High-output, High-torque Spindle Motor SJ-DG Series

- Addition of S3 rating (%ED rating) has improved output and torque acceleration/deceleration characteristics.
- Balance adjustment ring has been added to the counter-load side for fine tuning.
- Range S3 rating: 5.5 to 15 [kW]
- Maximum speed 10,000 or 12,000 [r/min]

Low-inertia, High-speed Spindle Motor SJ-DL Series

- The spindle motors are dedicated to tapping machines requiring faster drilling and tapping.
- The latest design technologies have made it possible to attain lower vibration and greater rigidity even with the lighter weight.
- Range 0.75~7.5 [kW]



Built-in Spindle Motor SJ-BG Series

- The electrical design has been optimized to increase the continuous rated torque per unit volume, contributing to the downsizing of spindle units.
- A mold with cooling jacket is available as an optional feature.

(Note 1) For servo motors only

SOFTWARE TOOLS

●Design

Servo motor selection

Set the machine constants according to the following explanation.

Calculation results of the spindle acceleration/ deceleration times

The spindle acceleration/ deceleration times are shown in a graph.

【NC Servo Selection】

Input the machine constants for selection of the optimum servo motor.
This function automatically calculates spindle acceleration/deceleration times and selects the optimum power supply unit.

Combine the parts to customize the screen without programming.

Customize buttons with original pictures.

【NC Designer2】

We provide a developmental environment where the MTB can customize screens easily.
Two types of screen development methods are available; the interpreter system (programming without C++) for simple screen development, and the compiler system with a complex controller (programming with C++).

Edit PLC program with PLC development tool of NC Trainer2 plus.

Customize a screen using NC Designer2 and check its operation using NC Trainer2 plus.

NC Trainer2 plus NC Designer2 NC Trainer2 plus

【NC Trainer2 plus】

NC Trainer2 plus supports customization development; it helps to program the ladder programming of the user PLC to be developed by machine tool builders and debug it and check the operations of customized screens.

●Training

Education

Operation check

Results

- Put skills obtained into practice
- Smooth start-up
- Quick setup/machining

【NC Trainer2 / NC Trainer2 plus】

This is an application for operating the CNC screen and machining programs on a computer without the CNC control unit or a special display unit. It can also be used for learning CNC operation and checking machining programs. The machining programs created on NC Trainer2/NC Trainer2 plus can be used on actual CNCs.

● Setup

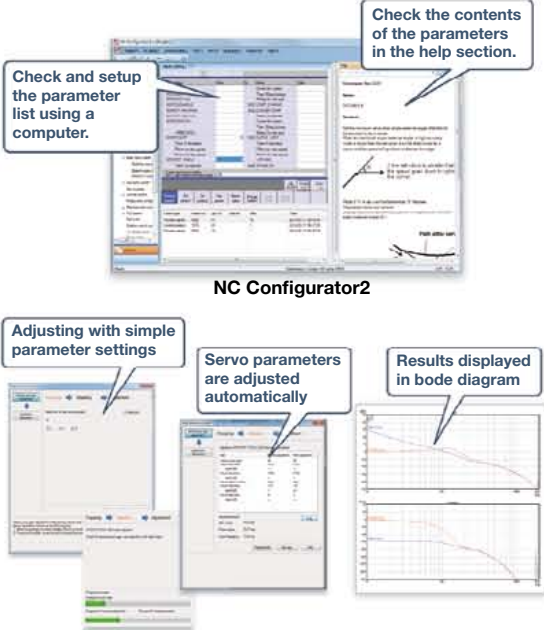

NC Configurator2

【NC Configurator2】

NC parameters required for NC control or machine operation can be edited on a computer. Also possible to create initial parameters simply by inputting the machine configuration.



NC Analyzer2

【NC Analyzer2】

Servo parameters can be adjusted automatically by measuring and analyzing the machine's characteristics. Measurement and analysis can be done by running a servo motor using the machining program for adjustment, or using the vibration signal. This function can sample various types of data.

● Operational Support

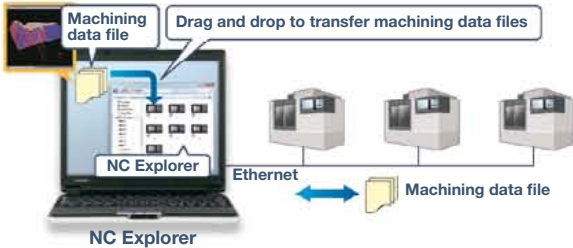

NC Explorer

【NC Explorer】

CNC machining data files can be manipulated using Windows® Explorer on a computer when the computer is connected to multiple CNCs via Ethernet.

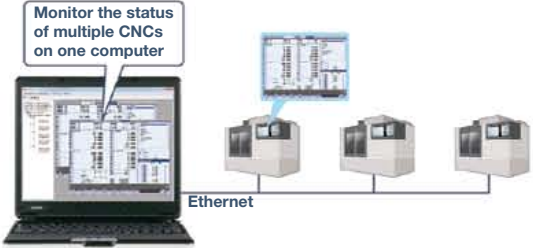

NC Monitor2

【NC Monitor2】

Taking advantage of the network in a plant, CNC operation status can be monitored from remote locations. Several CNCs can be connected and monitored simultaneously.

Global Service Network

To establish the best partnership with you, we offer reliable after services in each region of the world.



Germany FA Center/
IAM Showroom



Korea FA Center/IAM Showroom

EUROPE

- MITSUBISHI ELECTRIC EUROPE B.V.
European Service Headquarter
(Dusseldorf, GERMANY)
TEL: +49-2102-486-1850
FAX: +49-2102-486-5910
- South Germany Service Center (Stuttgart)
- France Service Center (Paris)
- France Service Satellite (Lyon)
- Italy Service Center (Milan)
- Italy Service Satellite (Padova)
- U.K. Service Center
- Spain Service Center
- Poland Service Center
- Hungary Service Center
- MITSUBISHI ELECTRIC TURKEY A.
Turkey Service Center
- Czech Republic Service Center (Service Partner)
- Russia Service Center (Service Partner)
- Sweden Service Center
- Bulgaria Service Center (Service Partner)
- Ukraine Service Center (Kharkov) (Service Partner)
- Belarus Service Center (Service Partner)
- South Africa Service Center (Service Partner)

KOREA

- MITSUBISHI ELECTRIC AUTOMATION
KOREA CO., LTD. (KOREA FA CENTER)
Korea Service Center
TEL: +82-2-3660-9609
FAX: +82-2-3664-8668
- Korea Daegu Service Satellite



Thailand FA Center

THAILAND

- MITSUBISHI ELECTRIC FACTORY
AUTOMATION (THAILAND) CO.,LTD
Thailand Service Center
TEL: +66-2-682-6522
FAX: +66-2-682-6020



India CNC Technical Center



INDIA

- MITSUBISHI ELECTRIC INDIA PVT., LTD.
CNC Technical Center (Bangalore)
TEL : +91-80-4655-2121
FAX : +91-80-4655-2147
- Chennai Service Satellite
- Coimbatore Service Satellite
- Hyderabad Service Satellite
- North India Service Center (Gurgaon)
- Ludhiana Satellite
- Panth Nagar Service Satellite
- Delhi Service Satellite
- Jamshedpur Service Satellite
- West India Service Center (Pune)
- Kollhapur Service Satellite
- Aurangabad Service Satellite
- Mumbai Service Satellite
- West India Service Center (Ahmedabad)
- Rajkot Service Satellite



ASEAN FA Center/
IAM Showroom



Malaysia FA Center





Nagoya Works



North America FA Center

AMERICA
 • MITSUBISHI ELECTRIC AUTOMATION INC.
 (AMERICA FA CENTER)
 Central Region Service Center (Chicago)
 TEL: +1-847-478-2500
 FAX: +1-847-478-2650

JAPAN
 • MITSUBISHI ELECTRIC CORPORATION
 (TOKYO HEAD OFFICE, NAGOYA WORKS)
 • MITSUBISHI ELECTRIC MECHATRONICS
 ENGINEERING CORPORATION
 (HEADQUARTER)
 TEL: +81-52-722-6620
 FAX: +81-52-722-6662

- Minneapolis, MN Service Satellite
- Detroit, MI Service Satellite
- Grand Rapids, MI Service Satellite
- Lima, OH Service Satellite
- Cleveland, OH Service Satellite
- Indianapolis, IN Service Satellite
- St. Louis, MO Service Satellite
- South/East Region Service Center (Georgia)
- Charleston, SC Service Satellite
- Charlotte, NC Service Satellite
- Raleigh, NC Service Satellite
- Dallas, TX Service Satellite
- Houston, TX Service Satellite
- Hartford, CT Service Satellite
- Knoxville, TN Service Satellite
- Nashville, TN Service Satellite
- Baltimore, MD Service Satellite
- Pittsburg, PA Service Satellite
- Allentown, PA Service Satellite
- Syracuse, NY Service Satellite
- Tampa, FL Service Satellite
- Lafayette, LA Service Satellite
- Western Region Service Center (California)
- San Francisco, CA Service Satellite
- Seattle, WA Service Satellite
- Canada Region Service Center (Tronto)
- Edmonton, AB Service Satellite
- Montreal, QC Service Satellite
- Mexico Region Service Center (Mexico City)
- Queretaro, MX Service Satellite
- Monterrey, MX Service Satellite



Taichung FA Center

TAIWAN
 • MITSUBISHI ELECTRIC TAIWAN CO., LTD.
 (TAIWAN FA CENTER)
 Taiwan Taichung Service Center
 TEL: +886-4-2359-0688
 FAX: +886-4-2359-0689

- Taiwan Taipei Service Center
- Taiwan Tainan Service Center

OCEANIA
 • MITSUBISHI ELECTRIC AUSTRALIA PTY. LTD.
 Oceania Service Center
 TEL: +61-2-9684-7269
 FAX: +61-2-9684-7245



Brazil Votorantim FA Center

BRAZIL
 • MELCO CNC do Brasil Comércio e Serviços Ltda.
 Brazil Region Service Center
 TEL: +55-15-3023-9000
 • JOVIMAQ – Joinville, SC Service Satellite
 • MAQSERVICE – Canoas, RS Service Satellite



MITSUBISHI ELECTRIC AUTOMATION MANUFACTURING (Changshu) Co., LTD.



Shanghai FA Center/AM Showroom

CHINA
 • MITSUBISHI ELECTRIC AUTOMATION (CHINA) LTD.
 (CHINA FA CENTER)
 China Shanghai Service Center
 TEL: +86-21-2322-3030
 FAX: +86-21-2322-3000*8422

- China Ningbo Service Partner
- China Wuxi Service Partner
- China Jinan Service Partner
- China Hangzhou Service Partner
- China Beijing Service Center
- China Beijing Service Partner
- China Tianjin Service Center
- China Chengdu Service Center
- China Shenzhen Service Center
- China Xiamen Service Partner
- China DongGuang Service Partner
- China Dalian Service Center

INDONESIA
 • PT. MITSUBISHI ELECTRIC INDONESIA
 Indonesia Service Center (Cikarang)
 TEL: +62-21-2961-7797
 FAX: +62-21-2961-7794

VIETNAM
 • MITSUBISHI ELECTRIC VIETNAM CO.,LTD
 Vietnam Ho Chi Minh Service Center
 TEL: +84-8-3910 5945
 FAX: +84-8-3910 5946
 • Vietnam Hanoi Service Center

MALAYSIA
 • MITSUBISHI ELECTRIC SALES MALAYSIA SDN. BHD.
 Malaysia Service Center (Kuala Lumpur Service Center)
 TEL: +60-3-7960-2628
 FAX: +60-3-7960-2629
 • Johor Bahru satellite

ASEAN
 • MITSUBISHI ELECTRIC ASIA PTE. LTD.
 (ASEAN FA CENTER)
 Singapore Service Center
 TEL: +65-6473-2308
 FAX: +65-6476-7439
 • Philippines Service Center (Service Partner)

WARRANTY

Please confirm the following product warranty details before using MITSUBISHI CNC.

1. Warranty Period and Coverage

Should any fault or defect (hereafter called "failure") for which we are liable occur in this product during the warranty period, we shall provide repair services at no cost through the distributor from which the product was purchased or through a Mitsubishi Electric service provider. Note, however that this shall not apply if the customer was informed prior to purchase of the product that the product is not covered under warranty. Also note that we are not responsible for any on-site readjustment and/or trial run that may be required after a defective unit is replaced.

[Warranty Term]

The term of warranty for this product shall be twenty-four (24) months from the date of delivery of product to the end user, provided the product purchased from us in Japan is installed in Japan (but in no event longer than thirty (30) months, including the distribution time after shipment from Mitsubishi Electric or its distributor).

Note that, for the case where the product purchased from us in or outside Japan is exported and installed in any country other than where it was purchased; please refer to "2. Service in overseas countries" as will be explained.

[Limitations]

(1) The customer is requested to conduct an initial failure diagnosis by him/herself, as a general rule. It can also be carried out by us or our service provider upon the customer's request and the actual cost will be charged.

(2) This warranty applies only when the conditions, method, environment, etc., of use are in compliance with the terms and conditions and instructions that are set forth in the instruction manual, user's manual, and the caution label affixed to the product, etc.

(3) Even during the term of warranty, repair costs shall be charged to the customer in the following cases:

(a) a failure caused by improper storage or handling, carelessness or negligence, etc., or a failure caused by the customer's hardware or software problem

(b) a failure caused by any alteration, etc., to the product made by the customer without

Mitsubishi Electric's approval

(c) a failure which may be regarded as avoidable, if the customer's equipment in which this product is incorporated is equipped with a safety device required by applicable laws or has any function or structure considered to be indispensable in the light of common sense in the industry

(d) a failure which may be regarded as avoidable if consumable parts designated in the instruction manual, etc. are duly maintained and replaced

(e) any replacement of consumable parts (including a battery, relay and fuse)

(f) a failure caused by external factors such as inevitable accidents, including without limitation fire and abnormal fluctuation of voltage, and acts of God, including without limitation earthquake, lightning, and natural disasters

(g) a failure which is unforeseeable under technologies available at the time of shipment of this product from our company

(h) any other failures which we are not responsible for or which the customer acknowledges we are not responsible for

2. Service in Overseas Countries

If the customer installs the product purchased from us in his/her machine or equipment, and export it to any country other than where he/she bought it, the customer may sign a paid warranty contract with our local FA center.

This falls under the case where the product purchased from us in or outside Japan is exported and installed in any country other than where it was purchased.

For details please contact the distributor from which the customer purchased the product.

3. Exclusion of Responsibility for Compensation against Loss of Opportunity, Secondary Loss, etc.

Regardless of the gratis warranty term, Mitsubishi shall not be liable for compensation to:

(1) Damages caused by any cause found not to be the responsibility of Mitsubishi.

(2) Loss in opportunity, lost profits incurred to the user by Failures of Mitsubishi products.

(3) Special damages and secondary damages whether foreseeable or not, compensation for accidents, and compensation

for damages to products other than Mitsubishi products.

(4) Replacement by the user, maintenance of on-site equipment, start-up test run and other tasks.

4. Changes in Product Specifications

Specifications shown in our catalogs, manuals or technical documents are subject to change without notice.

5. Product Application

(1) For the use of this product, its applications should be those that may not result in a serious damage even if any failure or malfunction occurs in the product, and a backup or fail-safe function should operate on an external system to the product when any failure or malfunction occurs.

(2) Mitsubishi CNC is designed and manufactured solely for applications to machine tools to be used for industrial purposes.

Do not use this product in any applications other than those specified above, especially those which are substantially influential on the public interest or which are expected to have significant influence on human lives or properties.

* Trademarks

MELDAS, MELSEC, EZSocket, EZMotion, iQ Platform, MELSOFT, GOT, CC-Link, CC-Link/LT and CC-Link IE are either trademarks or registered trademarks

of Mitsubishi Electric Corporation in Japan and/or other countries.

Ethernet is a registered trademark of Xerox Corporation in the United States and/or other countries.

Microsoft® and Windows® are either trademarks or registered trademarks of Microsoft Corporation in the United States and/or other countries.

SD logo and SDHC logo are either registered trademarks or trademarks of LLC.

Other company and product names that appear in this manual are trademarks or registered trademarks of the respective companies.

YOUR SOLUTION PARTNER

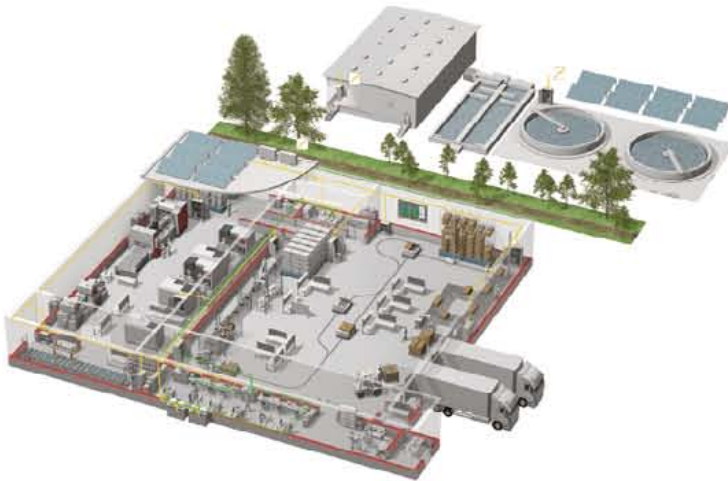

Mitsubishi Electric offers a wide range of automation equipment from PLCs and HMIs to CNC and EDM machines.

A NAME TO TRUST

Since its beginnings in 1870, some 45 companies use the Mitsubishi name, covering a spectrum of finance, commerce and industry.

The Mitsubishi brand name is recognized around the world as a symbol of premium quality.

Mitsubishi Electric Corporation is active in space development, transportation, semi-conductors, energy systems, communications and information processing, audio visual equipment and home electronics, building and energy management and automation systems, and has 237 factories and laboratories worldwide in over 121 countries.

This is why you can rely on Mitsubishi Electric automation solution - because we know first hand about the need for reliable, efficient, easy-to-use automation and control in our own factories.

As one of the world's leading companies with a global turnover of over 4 trillion Yen (over \$40 billion), employing over 100,000 people, Mitsubishi Electric has the resource and the commitment to deliver the ultimate in service and support as well as the best products.



Low voltage: MCCB, MCB, ACB



Medium voltage: VCB, VCC



Power monitoring, energy management



Compact and Modular Controllers



Inverters, Servos and Motors



Visualisation: HMIs



Numerical Control (NC)



Robots: SCARA, Articulated arm



Processing machines: EDM, Lasers, IDS



Transformers, Air conditioning, Photovoltaic systems

* Not all products are available in all countries.

Global Partner. Local Friend.



Safety Warning

To ensure proper use of the products listed in this catalog, please be sure to read the instruction manual prior to use.

Mitsubishi Electric Corporation Nagoya Works is a factory certified for ISO14001 (standards for environmental management systems) and ISO9001 (standards for quality assurance management systems)



MITSUBISHI ELECTRIC CORPORATION

HEAD OFFICE: TOKYO BLDG., 2-7-3, MARUNOUCHI, CHIYODA-KU, TOKYO 100-8310, JAPAN
<http://Global.MitsubishiElectric.com>